

AQA Physics A-level

Section 8: Nuclear physics Notes

3.8.1 Radioactivity

3.8.1.1 - Rutherford scattering

Rutherford scattering demonstrated the **existence of a nucleus**. Before this experiment scientists believed in **Thomson's plum pudding model**, which stated that the atom was made up of a **sphere of positive charge, with small areas of negative charge evenly distributed throughout** like plums in a plum pudding. Rutherford scattering led to the production of a new model for the atom, known as the **nuclear model** because the plum pudding model had been disproved.

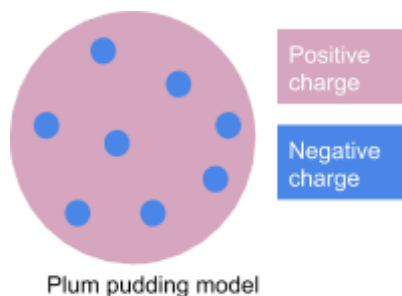

Rutherford's apparatus included an **alpha source and gold foil in an evacuated chamber which was covered in a fluorescent coating**, which meant you could see where the alpha particles hit the inside of the chamber. To observe the path of the alpha particles, there was a **microscope** which could be moved around the outside of the chamber.

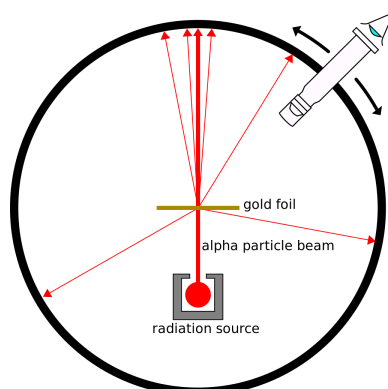

Image source: [Kurzong, CC BY-SA 3.0](https://www.kurzong.com/)

If the plum pudding model was true, the expected results would be that the positively charged alpha particles would be deflected by a very small amount when passing through the foil, however this was not what was observed:

- **Most alpha particles passed straight through the foil with no deflection** - this suggested that the **atom is mostly empty space** (and not a uniform density as suggested by the plum pudding model).
- **A small amount of particles were deflected by a large angle** - this suggested that the **centre of the atom is positively charged**, as positively charged alpha particles were repelled from the centre and deflected.
- **Very few particles were deflected back by more than 90°** - this suggested that the **centre of the atom was very dense** as it could deflect fast moving alpha particles, but

also that it was **very small** as a very small amount of particles were deflected by this amount.

From the above results it was concluded that the atom has a **small, dense, positively charged nucleus at its centre**.

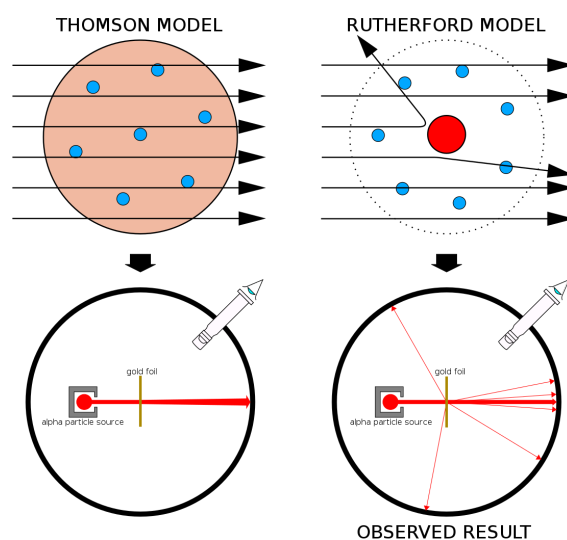

Image source: [Kurzon, CC BY-SA 3.0](https://www.kurzban.com/)

3.8.1.2 - α , β and γ radiation

Radiation is where an unstable nucleus emits energy in the form of EM waves or subatomic particles in order to become more stable. There are three types of radiation, all of which have different properties which are summarised in the table below:

Radiation	Range in air	Ionising	Deflected by electric and magnetic fields?	Absorbed by?
Alpha (α)	2 - 10 cm	Highly	Yes	Paper
Beta (β)	Around 1 m	Weakly	Yes	Aluminium foil (around 3 mm)
Gamma (γ)	Infinite range: follows inverse square law	Very weakly	No	Several metres of concrete or several inches of lead

Due to their **differing penetrating powers**, these type of radiation emitted from a source can be easily identified using a simple experiment:

- Using a geiger-muller (GM) tube and counter, find the **background count** when the source is not present.
- Place the source of radiation close to the GM tube and measure the count rate.

3. Place a **sheet of paper** between the source and GM tube and measure count rate again, if the **count rate decreases significantly, then the source is emitting alpha radiation**.
4. Repeat the above step using **aluminium foil** and **several inches of lead**. If there is a **significant decrease in count rate for aluminium foil, then beta radiation is being emitted** and if there is a **significant decrease in count rate for the lead block, then gamma radiation is being emitted**.

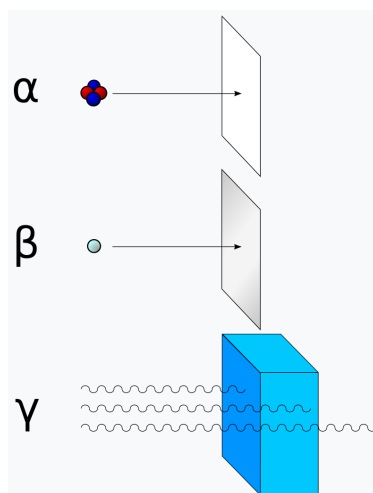

Image source: [Stannered, CC BY-SA 3.0](https://www.stannered.com/)

All three of these types of radiation can be used to **monitor the thickness of certain materials while they are being produced**, for example **in the production of aluminium foil a beta source is placed on one side of the material, while a detector is placed on the other**. If the material becomes **too thick, less beta radiation will pass through the foil**, therefore the reading on the detector decreases causing the rollers (which are flattening the foil) to move closer together, meanwhile if the material becomes **too thin, the reading will increase** causing the rollers to move apart. Using the same method, alpha radiation can be used for the production of paper, while gamma radiation can be used for the production of steel sheets.

Gamma radiation is very weakly ionising so does far less damage to our bodies than alpha and beta particles, meaning it can be used in medicine. There are many ways gamma radiation is used in medicine:

- **As a detector** - a radioactive source with a short half-life (to reduce exposure), which emits gamma radiation, can be injected into a patient and the gamma radiation can be detected using gamma cameras in order to **help diagnose patients**.
- **To sterilise surgical equipment** - as gamma radiation will kill any bacteria present on the equipment.
- **In radiation therapy** - gamma radiation can be used to **kill cancerous cells** in a targeted region of the body such as a tumour, however it will also kill any healthy cells in that region.

There are many benefits but also many risks involved in using gamma radiation in medicine, therefore many safety measures are put in place to reduce this risk to medical staff and patients e.g. reduced exposure times, use of shielding.

As gamma radiation moves through the air it **spreads out in all directions equally**, therefore the intensity of gamma radiation follows an **inverse square law** as shown by the formula:

$$I = \frac{k}{x^2}$$

Where I is the intensity of radiation, k is a constant, and x is the distance from the source.

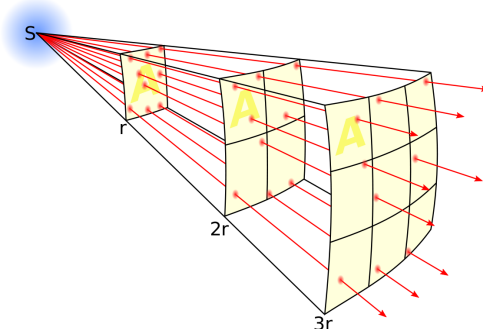

Image source: [Borb, CC BY-SA 3.0](#)

You can investigate this relationship using a simple experiment where you **measure the count rate of a gamma source at different distances from the GM tube**, making sure to adjust for the background radiation. Then you can plot a graph of corrected count against $\frac{1}{x^2}$, which will form a straight line verifying the above equation.

Alpha radiation is **highly ionising**, and therefore can be **incredibly dangerous if inhaled or ingested** as it can ionise body tissue. Beta particles are less ionising but can still cause damage to body tissue, and prolonged exposure to gamma radiation can cause mutations and damage to cells.

Due to the potential dangers of radiation, radioactive sources must be handled safely by:

- Using **long handled tongs** to move the source.
- Storing the source in a **lead-lined container** when not in use.
- **Keeping the source as far away as possible** from yourself and others.
- **Never pointing the source towards others.**

Background radiation is around us constantly, therefore when taking readings of count rate of a radioactive source it is important to **measure the background radiation first, then subtract this value** to find the **corrected count**, which is the actual count rate caused by the source.

$$\text{Corrected count} = \text{Total count rate} - \text{background count}$$

There are many sources of background radiation:

- **Radon gas** - which is released from rocks.
- **Artificial sources** - caused by **nuclear weapons testing** and **nuclear meltdowns**.
- **Cosmic rays** - enter the Earth's atmosphere from space.
- **Rocks** containing **naturally occurring radioactive isotopes**.

3.8.1.3 - Radioactive decay

Radioactive decay is a **random** process meaning you can't predict when the next decay will occur. A given radioactive nucleus will have a **constant decay probability** denoted by the letter λ , and known as the **decay constant**, which is the **probability of a nucleus decaying per unit time**. This value can be calculated by finding the **change in the number of nuclei (ΔN) of a sample over time (Δt), over the initial number of nuclei (N):**

$$\frac{\Delta N}{\Delta t} = -\lambda N$$

Over long periods of time radioactive decay can be described as an exponential decay through the following formula:

$$N = N_0 e^{-\lambda t}$$

Where N is the number of nuclei, N_0 is the initial number of nuclei, λ is the decay constant and t is time passed.

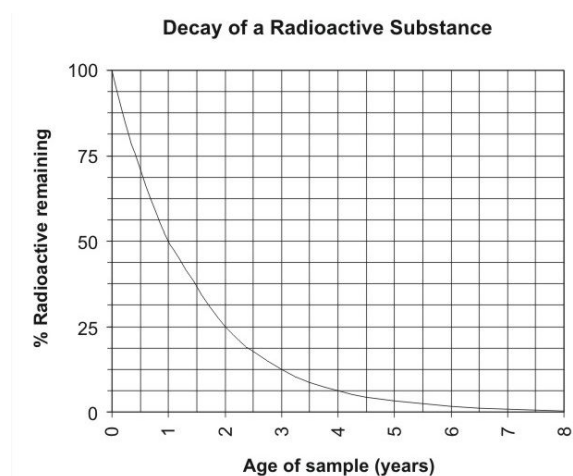

Image source: [Kurt Rosenkrantz, CC BY-SA 3.0](https://www.kurtrosenkrantz.com/)

As the decay is exponential, the **time taken for the number of nuclei to halve** will be constant, the name for this value is the **half-life ($T_{1/2}$)** of the sample. You can determine this value graphically, by **plotting a graph of the number of nuclei against time and measuring the time taken for the sample size to halve**, across several half-lives and finding a mean. For example, using the graph above, the time taken to drop to 25% is 2 years, therefore the half-life would be 1 year.

However, a more accurate way to measure half-life is by plotting a **graph of $\ln(N_0)$ against time**, which forms a straight line graph, the **modulus of the gradient of the line is the decay constant**, which can be used to find half-life. This is because:

$$\ln(N) = \ln(N_0 e^{-\lambda t})$$

$$\ln(N) = \ln(N_0) + \ln(e^{-\lambda t}) \quad \text{Using the log rule: } \log(AB) = \log(A) + \log(B)$$

$$\ln(N) = \ln(N_0) - \lambda t \quad \text{Rearrange to the form } Y = mx + c$$

$$\ln(N) = -\lambda t + \ln(N_0)$$

Using your measured value of decay constant you can use the following formula, (which is derived by substituting $0.5N_0$ for N in the exponential decay equation and rearranging for time):

$$T_{1/2} = \frac{\ln 2}{\lambda}$$

The **activity** of a radioactive sample is the **number of nuclei that decay per second**, this is proportional to the number of nuclei (N) in the sample, where the decay constant (λ) is the constant of proportionality:

$$A = \lambda N$$

Because activity is directly proportional to the number of nuclei it follows the same exponential decay equation:

$$A = A_0 e^{-\lambda t}$$

Also as they are proportional, the **time taken for activity to halve is equal to the half-life** as well, and as the activity of a sample is much easier to measure than the number of nuclei, this is often used to find the half-life of a sample.

The **decay constant** can be used to **model the decay of a nuclei only when there is a large number of nuclei in a sample**, this is because the decay constant models the number of nuclei decayed by statistical means.

The half-life of a radioactive nucleus will affect the way it can be used:

- **Dating of objects** - nuclei with a long half-life such as **carbon-14**, which has a half-life of 5730 years can be used to date **organic** objects, such as those found in archaeological sites. This is done by measuring the current amount of carbon-14 and comparing it to the initial amount, the percentage of which is approximately equal in all living things.
- **Medical diagnosis** - nuclei with relatively short half-lives are used as radioactive tracers in medical diagnosis. For example, **Technetium-99m** is ideal for use in medical diagnosis as it is a **pure gamma emitter**, it has a **half life of 6 hours**, which is short enough to limit exposure but long enough for tests to be carried out, and it can be easily **prepared on site**.

The **activity and half-life of radioactive nuclei will also affect the way they must be stored**, for example nuclei with an extremely long half-life will have to be suitably stored, for example in steel casks underground, **to prevent these nuclei from damaging the environment and the people that may be living around them hundred of years into the future**.

3.8.1.4 - Nuclear instability

Nuclei are **held together by the strong nuclear force**, however protons experience a force of **repulsion** due to the **electromagnetic force** and so if the forces are out of balance, the nuclei will become unstable and will experience radioactive decay. There are 4 reasons why a nucleus might become unstable, and depending on why a nucleus is unstable it will decay in a different way:

1. **It has too many neutrons** - Decays through **beta-minus emission** (or neutron emission in some circumstances), one of the neutrons in the nucleus changes into a proton and a

- beta-minus particle and antineutrino is released. The **nucleon number is constant, while the proton number increases by 1.**
2. **It has too many protons** - Decays through **beta-plus emission** or **electron capture**. In beta-plus decay a proton changes into a neutron and a beta-plus particle and neutrino is released. In electron capture, an orbiting electron is taken in by the nucleus and combined with a proton causing the formation of a neutron and neutrino. In both types of decay the **nucleon number stays constant, while the proton number decreases by 1.**
 3. **It has too many nucleons** - Decays through **alpha emission**, the **nucleon number decreases by 4 and proton number decreases by 2.**
 4. **It has too much energy** - Decays through **gamma emission**, this usually occurs after a different type of decay, such as alpha or beta decay because the nucleus becomes excited and has excess energy.

Nuclei may decay through several types of emission before finally becoming stable.

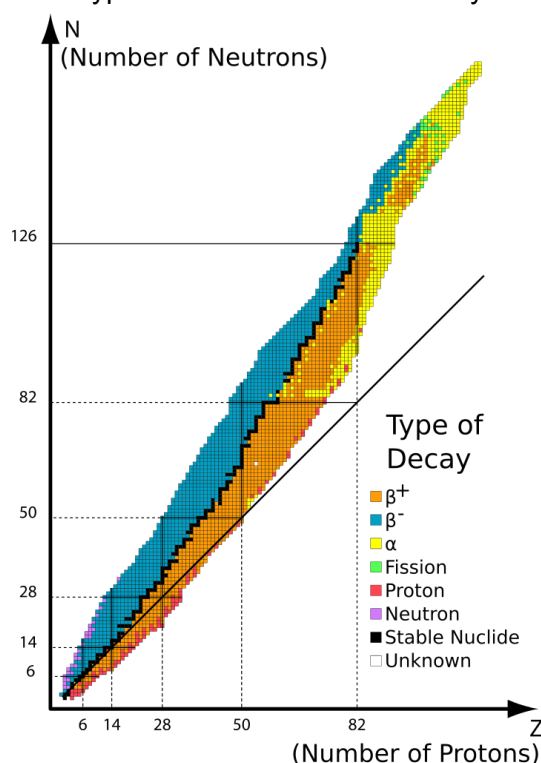
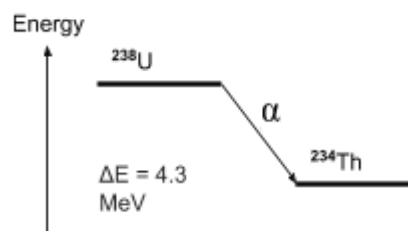
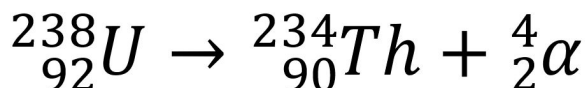

Image source: [Sjlegg, CC BY-SA 3.0](https://www.sjlegg.com)

As you can see from the graph of number of neutrons against the number of protons, the number of neutrons and protons in a stable nucleus does not increase uniformly beyond around 20 of each neutrons and protons. This is because beyond this amount the **electromagnetic force of repulsion becomes larger** than the strong nuclear force keeping the nucleus together, and so **more neutrons are needed to increase the distance between protons in order to decrease the magnitude of the electromagnetic force to keep the nucleus stable.**

You can represent nuclear decays by using **energy level diagrams** which show the differences in energy of particles. For example, below is the equation for an **alpha decay** and its corresponding energy level diagram.



This second example shows the **beta-minus decay** which forms **technetium-99m**, which is used in medicine:

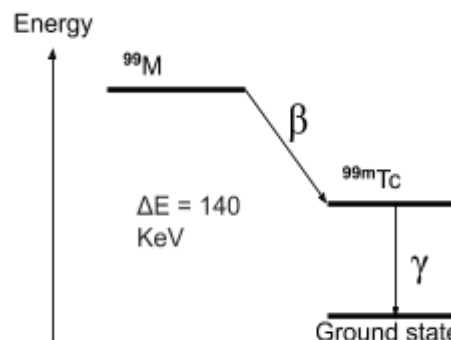
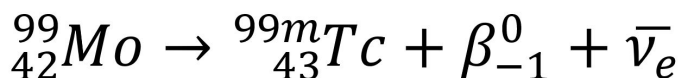

As you can see from the diagram the technetium is formed in an **excited nuclear state** therefore it will emit a gamma photon in order to reach the ground state, which makes it very useful in medical diagnosis. **Technetium-99m** is ideal for use in medical diagnosis as it is a **pure gamma emitter** - gamma rays can be easily detected by a gamma camera and are only very weakly ionising, it has a **half life of 6 hours**, which is short enough to limit exposure but long enough for tests to be carried out, and it can be easily **prepared on site**.

3.8.1.4 - Nuclear radius

You can estimate the nuclear radius of an atom by calculating the **distance of closest approach** of a charged particle. For example, an alpha particle fired at a gold nucleus will have an initial kinetic energy which can be measured, as it moves towards the **positively charged nucleus** it will experience an **electrostatic force of repulsion and slow down as its kinetic energy is converted to electric potential energy**. **The point at which the particle stops and has no kinetic energy is its distance of closest approach**, its electrical potential energy is equal to its initial kinetic energy due to conservation of energy. You can calculate this distance by using the equation of electric potential:

$$V = \frac{1}{4\pi\epsilon_0} \frac{Q}{r}$$

As **electric potential is the potential energy per unit charge** of a positive charge, **if we multiply this by the charge of our particle, we get an equation for the electric potential energy**.

$$E_{elec} = \frac{1}{4\pi\epsilon_0} \frac{Q_1 Q_2}{r}$$

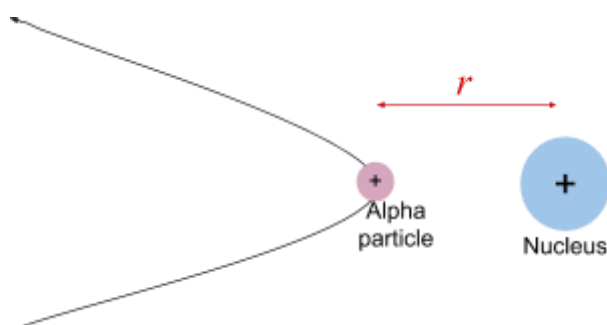

Where ϵ_0 is the permittivity of free space, Q_1/Q_2 is the charge of the nucleus/charged particle, r is the distance to the centre of the nucleus/distance of closest approach.

The distance of closest approach is not a very accurate estimate of nuclear radius as it will always be an overestimate, however there is another method for calculating nuclear radius which is called **electron diffraction**.

Electrons are **leptons** meaning **they will not interact with nucleons in the nucleus through the strong nuclear force** as an alpha particle would, and so electron diffraction gives a far more accurate estimate of nuclear radius.

The electrons are accelerated to very high speeds so that their **De Broglie wavelength** is around 10^{-15} m, and are directed a very thin film of material in front of a screen causing them to diffract through the gaps between nuclei and form a diffraction pattern.

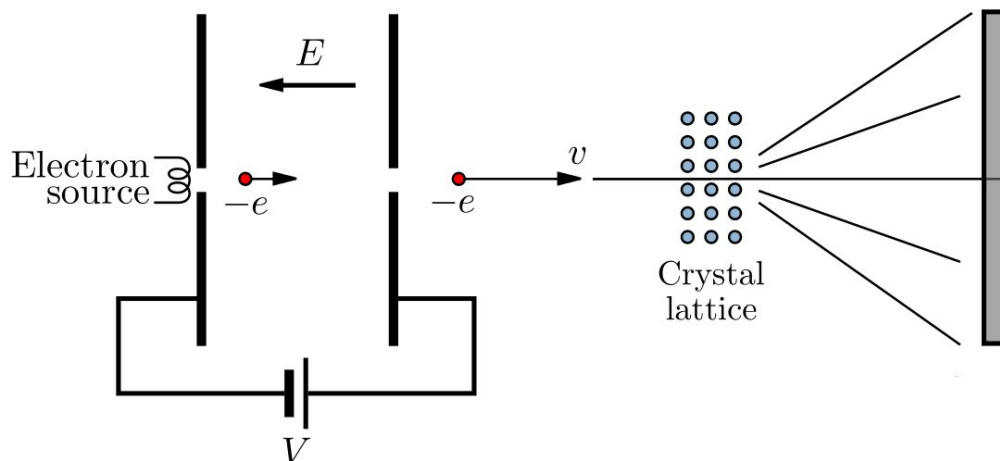

The diffraction pattern formed is a set of concentric circles, with a central bright spot, which get **dimmer as you move away from the centre**, using this pattern you can plot a **graph of intensity against diffraction angle** from which you can find the diffraction angle of the first minimum.

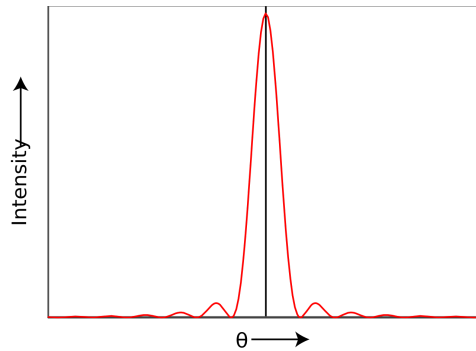

Using this measurement you can find an estimate of nuclear radius by using the following formula:

$$\sin \theta = \frac{0.61\lambda}{R}$$

Where θ is the diffraction angle of the first minimum, λ is the De Broglie wavelength of the electrons and R is the radius of the nucleus that the electrons were scattered by.

You can use the above method measure the nuclear radius of different atoms, and plot a graph of nuclear radius against nucleon number. The **radius of any nucleus is around 1×10^{-15} m**, however this varies a bit because as nucleon number increases so does nuclear radius. The graph below shows no clear trend between nuclear radius and nucleon number:

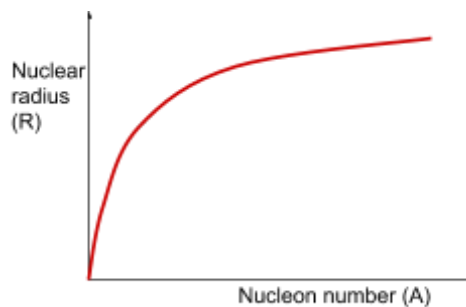

However if you plot a **log** the relationship between them:

$$R = kA^n \quad \text{Where } k \text{ is a}$$

graph you will be able to find

constant

$$\ln R = \ln(kA^n)$$

$$\ln R = \ln(k) + n \ln(A) \quad \text{Using the log laws: } \ln(AB) = \ln(A) + \ln(B) \text{ and } \ln(A^n) = n \ln(A)$$

If you plot a **graph of $\ln(R)$ against $\ln(A)$** , the **gradient will give you the relationship between them**, and measuring the **y-intercept** will give you the value of **$\ln(k)$** .

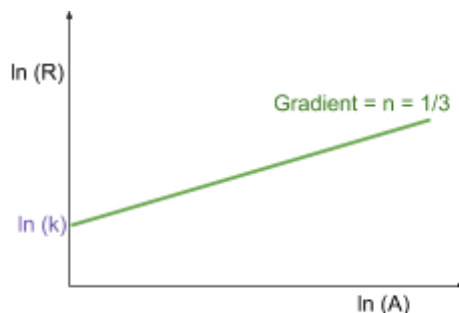

If you carry out this investigation you will find that **n is 1/3**, and k is approximately **1.4 fm**, the constant k is renamed R_0 and the following equation can be formed:

$$R = R_0 A^{1/3}$$

Using the above equation we can show that **nuclear density is constant** for all nuclei:

$$\begin{aligned} \text{density} &= \frac{\text{mass}}{\text{volume}} \\ &= \frac{A \times m_{\text{nucleon}}}{\frac{4}{3}\pi R^3} && \text{Substitute the above formula} \\ &= \frac{A \times m_{\text{nucleon}}}{\frac{4}{3}\pi (R_0 A^{1/3})^3} && = \frac{A \times m_{\text{nucleon}}}{\frac{4}{3}\pi R_0^3 A} && = \frac{m_{\text{nucleon}}}{\frac{4}{3}\pi R_0^3} = \text{constant value} \end{aligned}$$

You can follow the above method to find the density of any nucleus.

As the variable A is cancelled out and only constant values remain, this shows **nuclear density is constant**. The calculated value of nuclear density is around $1.45 \times 10^{17} \text{ kgm}^{-3}$, which is much larger than the density of an atom, suggesting an atom is mostly empty space with most of its mass concentrated in its centre.

3.8.1.6 - Mass and energy

At the nuclear level **mass and energy are interchangeable** and can be related by the equation, which **applies to all energy changes**:

$$E = mc^2$$

Where E is energy, m is mass and c is the speed of light in a vacuum.

When measuring the mass of a nucleus and the mass of its constituents, you will notice that the **mass of the nucleus is always lower**, this difference is known as the **mass defect / mass difference**. **The mass that is "lost" is converted into energy and released** when the nucleons fuse to form a nucleus.

The **binding energy** of a nucleus is the **energy required to separate the nucleus into its constituents (nucleons)** (or the energy released when a nucleus is formed from its constituents).

The change in mass when nucleons fuse is incredibly small, therefore when measuring the mass difference, **atomic mass units** are used. One atomic mass unit (1 u) is defined as **1/12th of the mass of a carbon-12 atom**, which is $1.661 \times 10^{-27} \text{ kg}$. You can convert atomic mass units to kg by multiplying them by $1.661 \times 10^{-27} \text{ kg}$, and then use the above equation to find the energy released in joules, however you could also simply use the fact that **a change in 1 u of mass means that 931.5 MeV of energy is released**.

Nuclear fission is the **splitting of a large nucleus into two daughter nuclei**. It occurs in very large nuclei, which are **unstable** (such as uranium), and occurs completely randomly, however it can also be induced. **Energy is released during fission because the smaller daughter nuclei have a higher binding energy per nucleon**. The image below shows the induced fission of uranium-235.

Nuclear fusion is the opposite of fission, it is where **two smaller nuclei join together to form one larger nucleus**. It only occurs in fairly small nuclei. **Energy is released during fusion because the larger nucleus has a much higher binding energy per nucleon**. Fusion releases far more energy than fission however fusion can only occur at **extremely high temperatures** (for example in stars) because a massive amount of energy is required to overcome the electrostatic force of repulsion between nuclei.

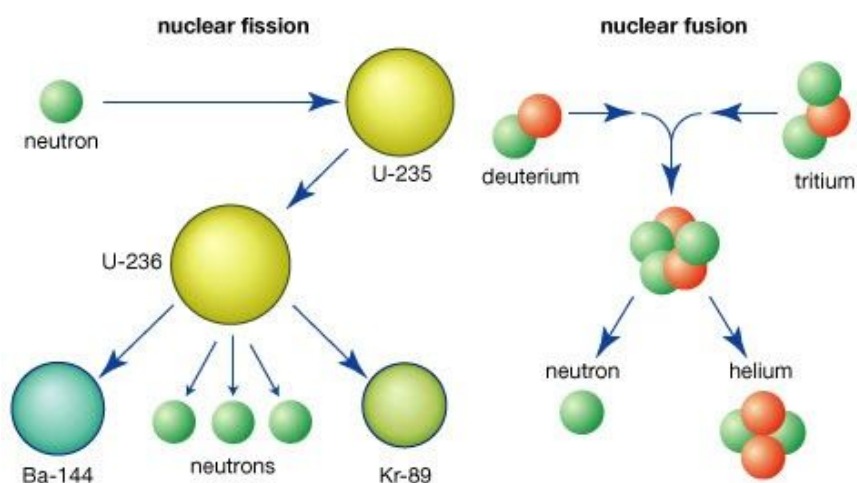
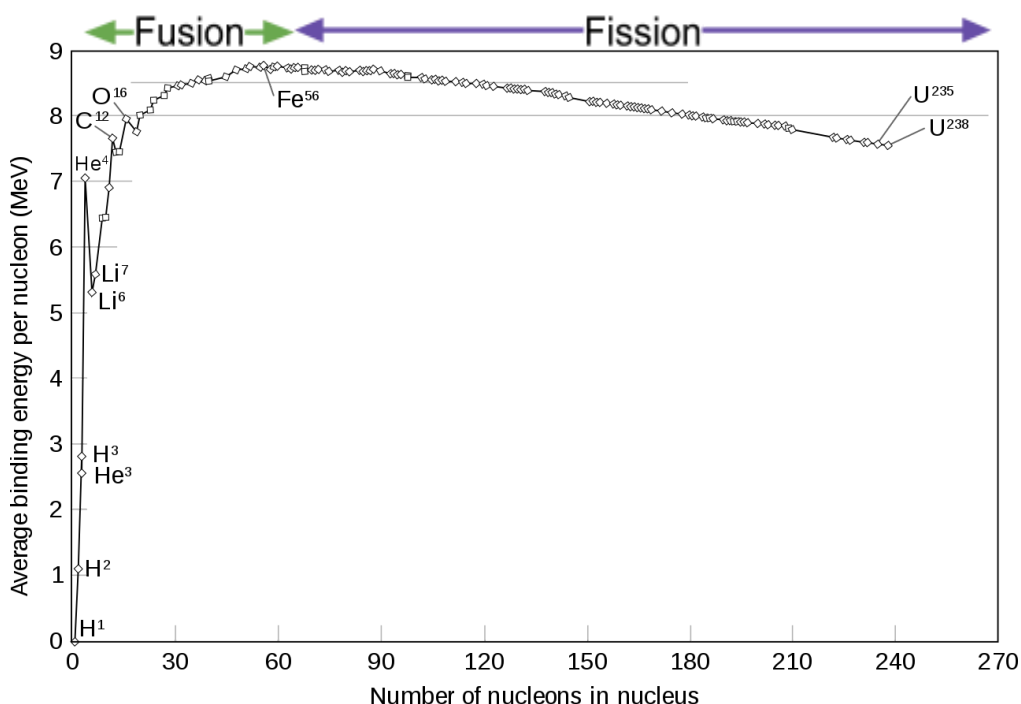

Image source: [Padsot1, CC BY-SA 4.0](https://www.padsot.com/)

The **binding energy per nucleon** is simply the binding energy of a nucleus divided by the number of nucleons in the nucleus. By plotting a graph of **binding energy per nucleon against nucleon number**, you can identify whether an element can undergo fission or fusion. As you can see on the graph, it has a characteristic curve which shows a dramatic difference in binding energy per nucleon for small nuclei. The peak of the curve occurs at a nucleon number of 56; the element **iron** has the highest binding energy per nucleon, **nuclei smaller than iron can undergo fusion, while elements larger than iron can undergo fission**.



You can also use the above graph to calculate the energy released in a fission or fusion reaction by calculating the change in energy between the nuclei.

Nuclear fission is used in nuclear power plants in order to create electricity **without the emission of greenhouse gases**, however there are many risks that come with this benefit. For example, the daughter nuclei produced in fission are **radioactive** and will need to be stored safely for thousands of years, and **meltdowns** in nuclear power plants are always a possibility and can cause devastating harm to the environment. **Understanding the nuclear physics behind the production of nuclear power allows society to make informed decisions** about how electricity should be generated.

Below are some example calculations:

Find the binding energy of a nucleus in eV, given that its mass defect is 0.0647 u.

Method 1: Convert the mass defect into kg and use $E = mc^2$ to find binding energy in joules then convert it to eV.

$$0.0647 \text{ u} = 0.0647 \times 1.661 \times 10^{-27} \text{ kg} = 1.074667 \times 10^{-28} \text{ kg}$$

$$E = 1.074667 \times 10^{-28} \times (3 \times 10^8)^2 = 9.672 \times 10^{-12} \text{ J}$$

$$\frac{9.672 \times 10^{-12}}{1.6 \times 10^{-19}} = 6.0 \times 10^7 \text{ eV} = 60 \text{ MeV (2 s.f.)}$$

Method 2: Use the fact that a mass defect of 1 u is equivalent to 931.5 MeV of energy released.

$$0.0647 \times 931.5 = 60 \text{ MeV (2 s.f.)}$$

Find the energy released in MeV when a uranium-235 nucleus splits into barium-144 and krypton-89 and 2 neutrons.

Name	Mass (u)
U-235 nucleus	235.043930
Ba-144 nucleus	143.922953
Kr-89 nucleus	88.91763
Neutron	1.008664

First calculate the mass defect using the information above:

$$\text{Mass before} = 235.043930 \text{ u}$$

$$\text{Mass after} = 143.922953 + 88.91763 + 2(1.008664) = 234.857911 \text{ u}$$

Mass defect = Mass before - Mass after

$$\text{Mass defect} = 235.043930 - 234.857911 = 0.186019 \text{ u}$$

Now multiply the mass defect by 931.5 to get energy released in MeV:

$$0.186019 \times 931.5 = 173 \text{ MeV (3 s.f.)}$$

3.8.1.7 - Induced fission

Fission can be **induced** in certain elements such as uranium-235, this is done by firing a **thermal neutron** into the uranium nucleus causing it to become **extremely unstable**. **Thermal neutrons** have a **low energy** meaning they can induce fission whereas **neutrons with a higher energy rebound** away from the uranium-235 after a collision and do not cause a fission reaction. The products of fission are two daughter nuclei and at least one neutron. The neutrons released during fission go on to cause more fission reactions forming a **chain reaction**, where each fission goes on to cause at least one more fission.

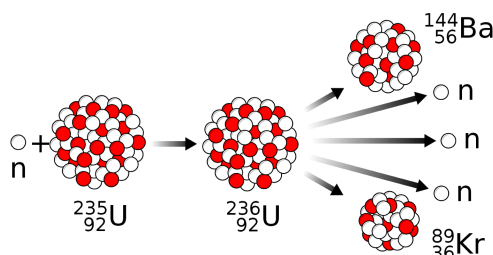

Image source: [MikeRun, CC BY-SA 4.0](https://creativecommons.org/licenses/by-sa/4.0/)

The **critical mass** is the **minimum mass of fuel required to maintain a steady chain reaction**. Using exactly the critical mass of fuel will mean that a single fission reaction follows the last, while using less than the critical mass would lead the reaction to eventually stop.

A nuclear reactor has several key features:

- **Moderator** - this **slows down the neutrons released in fission reactions to thermal speeds** through **elastic collisions** between the nuclei of the moderator atoms and the fission neutrons. The **closer the moderator atoms are in size to a neutron, the larger the proportion of momentum which is transferred**, therefore the lower the number of collisions required to get the neutrons to thermal speeds. Because of this, **water** is often used as a moderator as it contains hydrogen, also it's **inexpensive** and **not very reactive** making it a good material for a moderator. **Graphite** is also sometimes used as a moderator.
- **Control rods** - **absorb neutrons in the reactor in order to control chain reactions**. The height of the control rods in the nuclear reactor can be controlled, in order to control the rate at which fission reactions occur to **control the amount of energy produced**. They are made of materials which absorb neutrons without undergoing fission such as **boron** and **cadmium**.
- **Coolant** - **absorbs the heat released during fission reactions in the core of the reactor**. This heat is then used to make **steam which powers electricity-generating turbines**. Sometimes, **water** is both the coolant and moderator as it has a **high specific heat capacity** meaning it can transfer large amounts of thermal energy. Other materials such as **molten salt** or **gas (e.g helium)** can be used as a coolant.

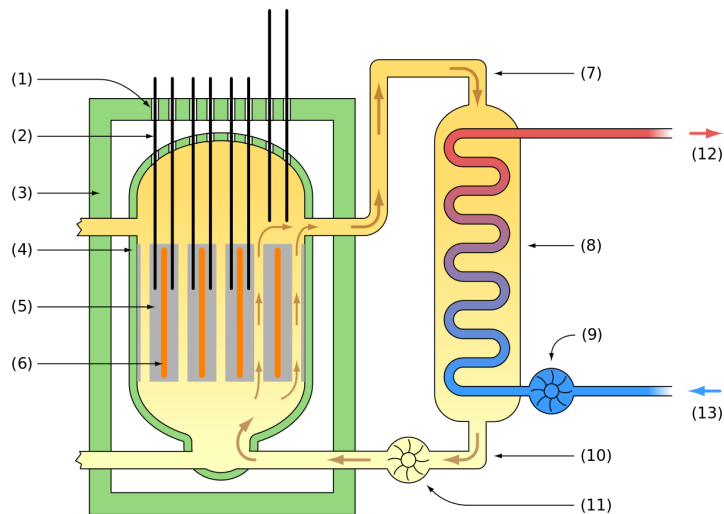

Image source: [Emoscopes, CC BY-SA 3.0](https://www.emoscopes.com/)

3.8.1.8 - Safety aspects

The fuel used in nuclear reactors is called **enriched uranium**, which is formed through the enrichment of mined uranium which consists of around 99% U-238, which does not experience fission in order to increase the percentage of **U-235 to around 5%**. The U-238 **absorbs fission neutrons** and so helps to control the rate of fission reactions. The fuel rods are inserted into the reactor **remotely** to limit the worker's exposure to radiation.

Around the nuclear reactor is a **very thick concrete shielding**, which **blocks radiation from escaping from the reactor and affecting the workers in the power station**. The **shielding may become radioactive** after long term use because neutrons which escape the reactor may enter the shielding nuclei causing them to become unstable and start experiencing beta-minus decay.

In an emergency, the **control rods are dropped into the reactor core entirely** in order to stop fission reactions from occurring as soon as possible by absorbing all the free neutrons in the core, this is known as an **emergency shut-down**.

During a fission reaction two daughter nuclei are produced, these nuclei are **usually extremely unstable and have a very high activity**, so need to be disposed of responsibly, because of this **spent fuel rods** are some of the most dangerous types of nuclear waste (known as **high-level**

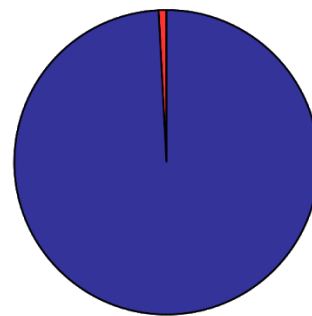

Natural uranium (NU)
>99.2% U-238
≤0.72% U-235

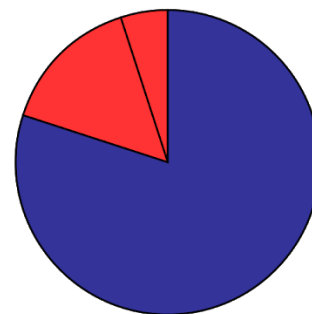

Low-enriched uranium (LEU)
(reactor grade)
<20% U-235
(typically 3-5% U-235)

waste). Another type of waste is **low-level waste**, which contains only **short-lived radioactivity** e.g. tools and gloves. Low-level waste can be disposed of close to the surface as it **will not take very long to stop being radioactive**, however not the same can be said about high-level waste which **can stay radioactive for thousands of years** so it must be processed very carefully:

1. The waste is removed and handled **remotely**, so that exposure is limited.
2. Any material removed from the reactor will be extremely hot due to fission reactions occurring within the reactor, so they must be placed in **cooling ponds** for up to a year while they may still be producing heat due to radioactive emissions. Cooling ponds are usually on the same site as the reactor or very close by so that these materials do not have to be transported through long distances, which will increase the risk of exposure.
3. At this point any plutonium or usable uranium is removed from spent fuel rods in order to be recycled.
4. The waste is then **vitrified** (encased in glass) and placed in **thick steel casks** and stored in **deep caverns** in **geologically stable locations**, so that there is no chance of the waste coming free of its casing. Locations to store radioactive waste are chosen so that they make a **minimal impact on the environment and people living in the area are consulted about it beforehand**.

Nuclear power stations produce **no polluting gases**, are **reliable** for production of power, and need **far less fuel** (only 1 kg of uranium gives as much power as 25 tonnes of coal), however they produce **radioactive waste**, and a **nuclear meltdown** could have catastrophic consequences. The **risks and benefits of nuclear power stations must be balanced**, therefore risks are minimised as far as possible through the above safety aspects to make sure the **benefits of nuclear power outweigh the risks**.